BuzziSkin Cuts

Product Specification Sheet

This document contains technical information about the BuzziSkin Cuts



www.buzzi.space



Felt shapes with self-adhesive backing

Add more punch to your wall or surface with BuzziSkin Cuts and create a little piece of art with the different shapes in striking colors.

Design by Sas Adriaenssens

General

- 📍 Round | Square | Penta | Hexa | Plank
- 🌲 Front Layer: BuzziFelt
Back Layer: Self-adhesive BuzziSkin
- ⚠️ Wall only, not recommended for ceiling or horizontal applications
No claims concerning deviation will be accepted

Certifications

CE

Acoustics



Absorption

Content



Configurations	3
Fabrics	5
Dimensions	6
Acoustics	7

Configurations

BuzziSkin Cuts Round

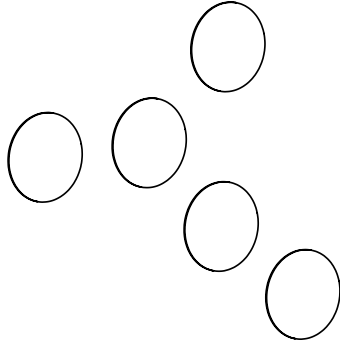
Example composition (can be ordered per piece)





-  Front Layer: BuzziFelt
Back Layer: Self-adhesive BuzziSkin
-  Ø 38 cm D 0,6 cm
Ø 14.96" D 1.57"
-  125 gr
4.41 oz

BuzziSkin Cuts Square

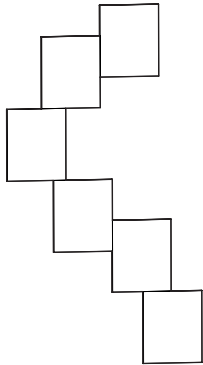
Example composition (can be ordered per piece)





-  Front Layer: BuzziFelt
Back Layer: Self-adhesive BuzziSkin
-  W 38 cm H 38 cm D 0,6 cm
W 14.96" H 14,96" D 0.24"
-  160 gr
4.41 oz

BuzziSkin Cuts Penta

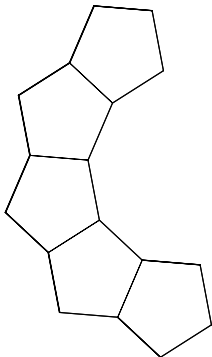
Example composition (can be ordered per piece)





-  Front Layer: BuzziFelt
Back Layer: Self-adhesive BuzziSkin
-  W 63 cm H 60 cm D 0,6 cm
W 24.80" H 23.62" D 1.57"
-  300 gr
10.58 oz

BuzziSkin Cuts Hexa

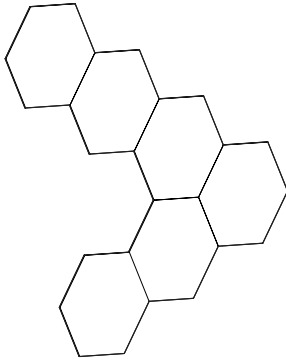
Example composition (can be ordered per piece)





-  Front Layer: BuzziFelt
Back Layer: Self-adhesive BuzziSkin
-  W 69,3 cm H 60 cm D 0,6 cm
W 27.28" H 23.62" D 0.24"
-  350 gr
12.35 oz

BuzziSkin Cuts Plank

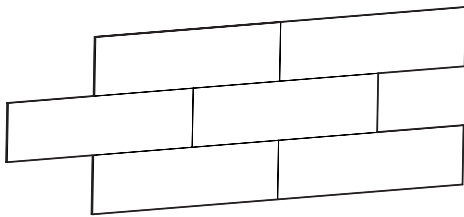
Example composition (can be ordered per piece)



-  Front Layer: BuzziFelt
Back Layer: Self-adhesive BuzziSkin
-  W 118 cm H 24 cm D 0,6 cm
W 46.46" H 9.45" D 0.24"
-  320 gr
11.29 oz

Fabrics

Skin

Composition 100% Recycled P.E.T. Felt, selfadhesive backing

Weight 1.000 g/m² | 29.49 oz/yd²

Abrasion resistance >7.000 Martindale

Flammability EU: EN 13501.1:2013 Class C-s2,d0
USA: ASTM E84 Class A certified

Fastness to light USA 5

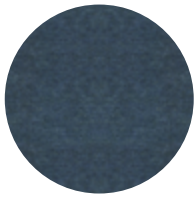

SK-Jeans 75



SK-StoneGrey 67

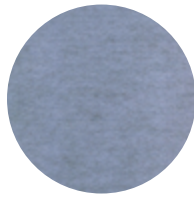

SK-LightBlue 60

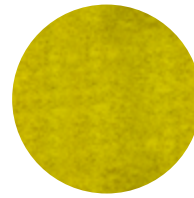

SK-Curry 61



SK-OffWhite 63



SK-Mokka 74



SK-EcoBrown 58

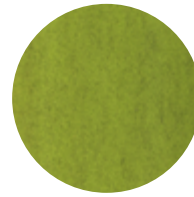

SK-Lime 64



SK-Pink 65

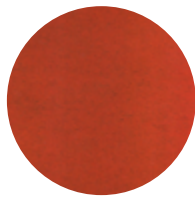

SK-Orange 66



SK-Red 59

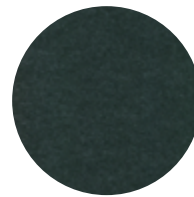

SK-Anthracite 68

Dimensions

Round

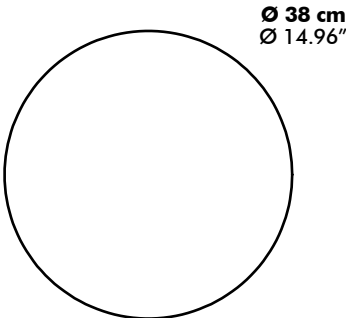

Square

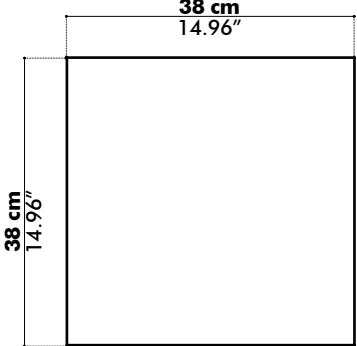

Penta

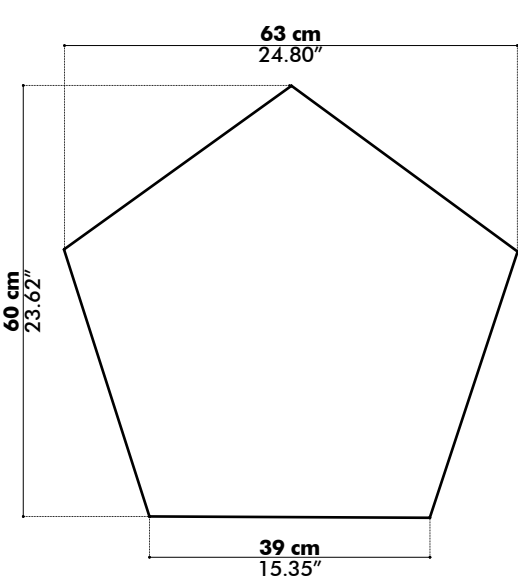

Hexa

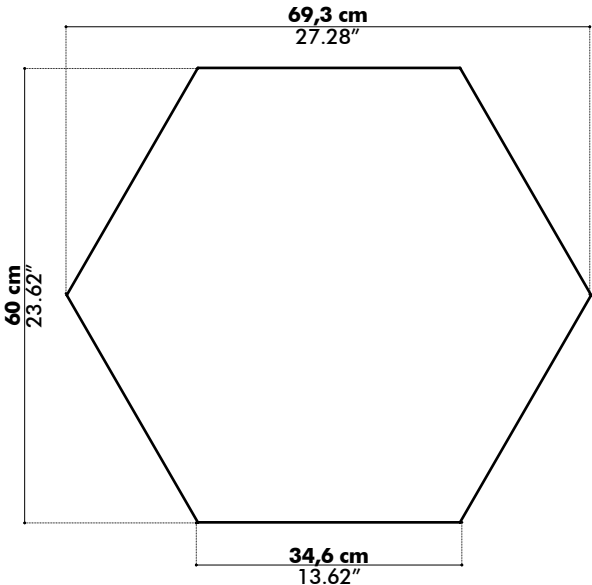

Plank

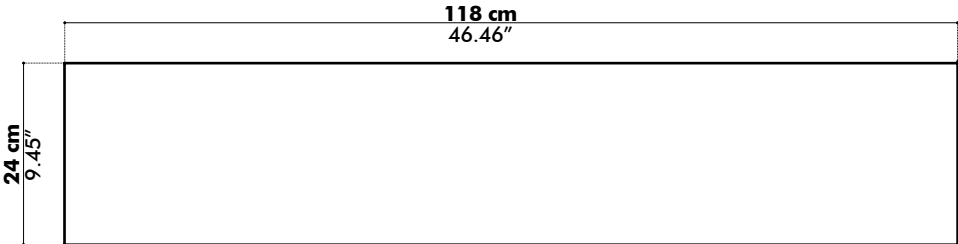

Acoustics

BuzziSkin Cuts

Absorption coefficient

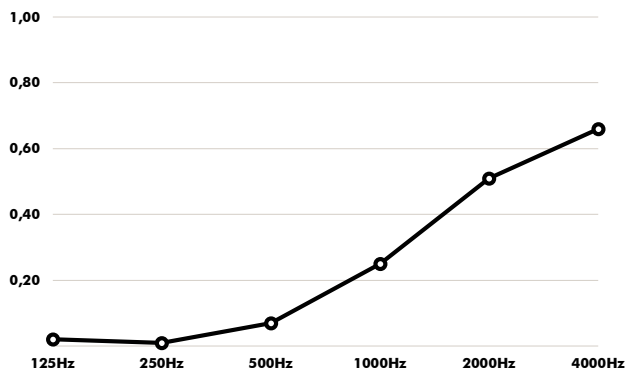

Hz	α^s
125	0.02
250	0.01
500	0.07
1000	0.25
2000	1.00
4000	0.93

Absorption Values

α_w (ISO 11654) **0.15**

NRC (ASTM - C423) **0.20**

SAA (ASTM-C423) **0.21**

Glossary

All calculations are based on accredited lab measurements, official document available on Buzzi.Space

Definitions

α	Weighted absorption coefficient	(ISO 11654)
NRC	Noise reduction coefficient	(ASTM - C423)
SAA	Sound absorption average	(ASTM - C423)

Classification of sound absorbers NEN-EN-ISO 11654

- A** 0.90 | 0.95 | 1.0
- B** 0.80 | 0.85
- C** 0.60 | 0.65 | 0.70 | 0.75
- D** 0.03 | 0.55
- E** 0.15 | 0.25